

PLAN VIEW - STYLE "A"

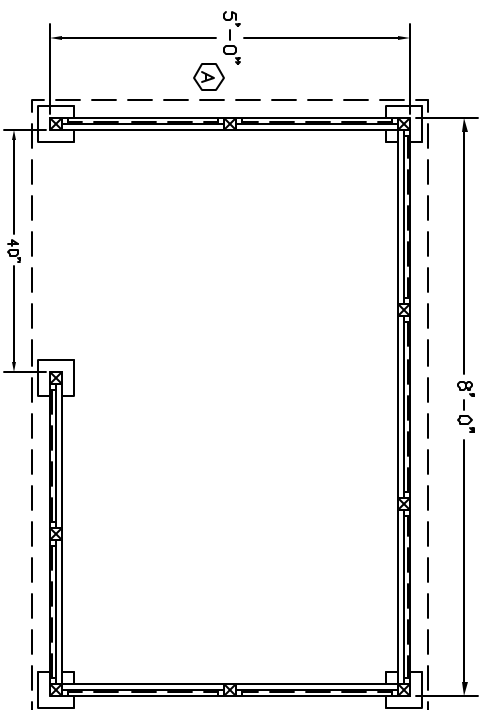

PLAN VIEW - STYLE "B"

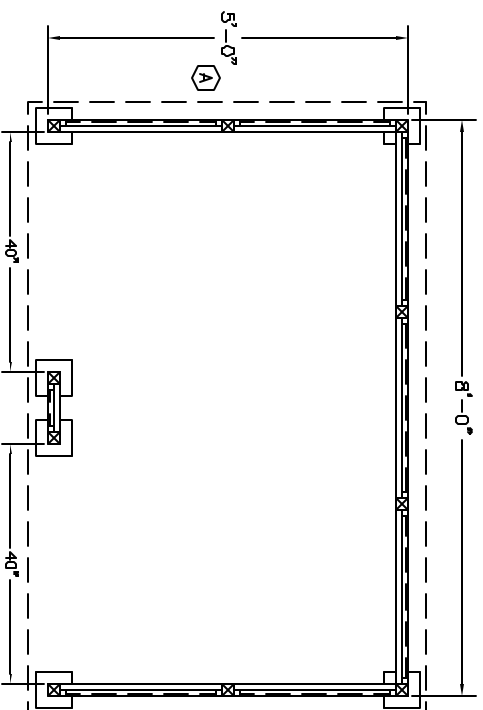

PLAN VIEW - STYLE "C"

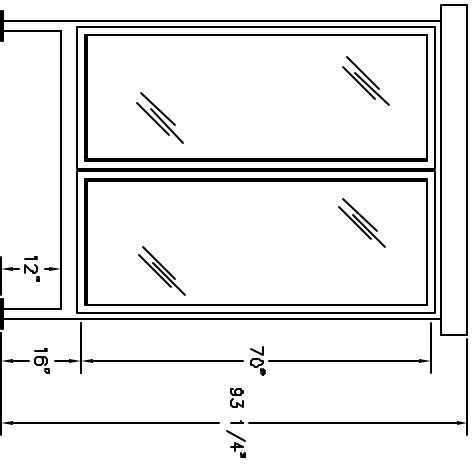

ELEVATION A

- SHELTER MODEL SMK85 NOTES :
- * WELDED STEEL CONSTRUCTION, PAINTED ONE COLOR
 - * 3" OVERHANG EXTERIOR ROOF
 - * CLEAR ANODIZED ALUMINUM FIXED WINDOW FRAMES
 - * CLEAR TEMPERED GLAZING

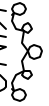
PORTA-KING BUILDING SYSTEMS

4133 SHORELINE DRIVE
 1-800-456-5464 FAX 314-291-2857 www.portaking.com
 EARTH CITY, MISSOURI 63045

TITLE SHELTER MODEL SMK85